

**dekopro**  
mouldings



**ARCHITECTURAL  
MOULDINGS  
RANGE**

## **DEKOPRO ARCHITECTURAL PRODUCTS**

DekoPro supply a complete range of exterior decorative architectural mouldings for residential and commercial builders, architects, home owners and DIY renovators. Our lightweight design, durability, precision shape profile and aesthetic appeal make them the choice for astute designers.

DekoPro offers decorative architectural mouldings in three forms. Lightweight Cement Coated EPS, Lightweight Casted Cement (solid or core filled) and GRC (glass reinforced concrete). All types are suitable to be fixed to range of substrates such as brickwork, pre-cast concrete panels, blockwork and various lightweight cladding. Supplied in a natural cement colour that can be easily painted to suit individual projects.

Choose from our wide range of architraves, window sills, stringers, plinths and parapets to achieve virtually any style or effect you desire from Georgian, French Provincial, Edwardian or Traditional Victorian to Tudor, Federation, Romanesque and even Art Deco.

We offer you a wide range of other decorative lightweight products including pier and fence cappings, corbels, keystones, plaques, embellishments, quoins, columns, pilasters and profiled arches and curves that are made to order to suit specific requirements.

On your next project whether it be residential or commercial, you can be sure that DekoPro the Decorative Moulding Professionals has the specific architectural lightweight product to finish your project to perfection.

## **CONTENTS**

<b>WINDOW ARCHITRAVES</b>	<b>PG 3-4</b>
<b>WINDOW SILLS</b>	<b>PG 5</b>
<b>PARAPETS</b>	<b>PG 6-8</b>
<b>PLINTHS</b>	<b>PG 9</b>
<b>STRINGERS</b>	<b>PG 10-11</b>
<b>FLAT BANDS</b>	<b>PG 12</b>
<b>BANDS</b>	<b>PG 13</b>
<b>PIER CAPPINGS</b>	<b>PG 14-15</b>
<b>QUOINS</b>	<b>PG 16</b>

This Information is presented to provide an introduction to the product range offered by Dekopro. Where dimensions are shown, they are intended to be a guide only and may be subject to change without given notice. For critical applications please confirm actual dimensions with your Dekopro sales representative.

## WA-101

3 Dimensional Visualisation

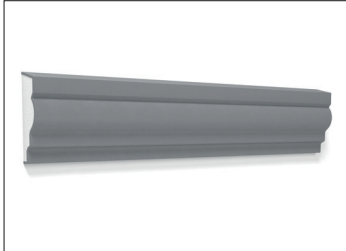

Side Profile

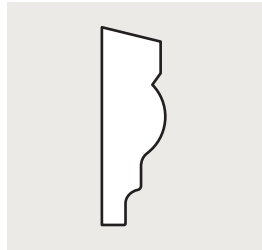

Dimensions:  
**75mm(h) x 25mm(w)**

## WA-102

3 Dimensional Visualisation

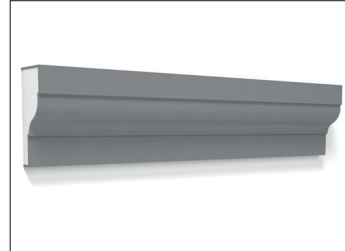

Side Profile

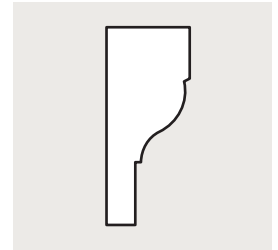

Dimensions:  
**80mm(h) x 35mm(w)**

## WA-103

3 Dimensional Visualisation

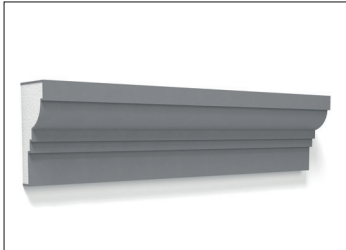

Side Profile

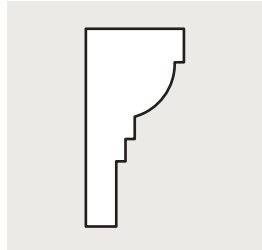

Dimensions:  
**90mm(h) x 45mm(w)**

## WA-104

3 Dimensional Visualisation

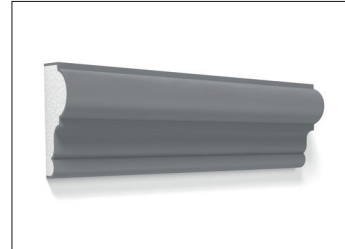

Side Profile

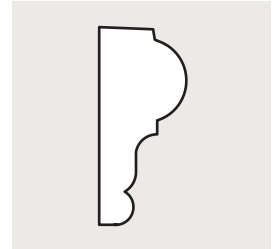

Dimensions:  
**90mm(h) x 40mm(w)**

## WA-105

3 Dimensional Visualisation

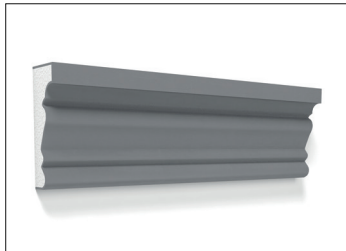

Side Profile

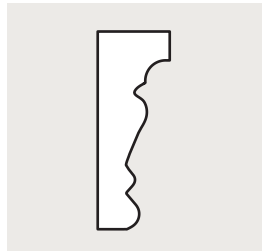

Dimensions:  
**95mm(h) x 35mm(w)**

## WA-106

3 Dimensional Visualisation

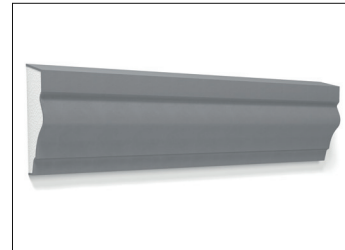

Side Profile

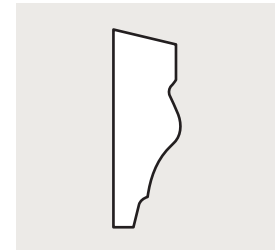

Dimensions:  
**95mm(h) x 35mm(w)**

## WA-107

3 Dimensional Visualisation

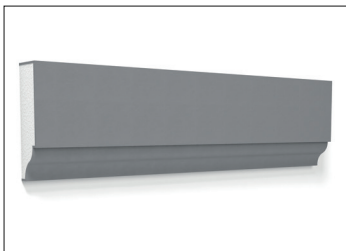

Side Profile

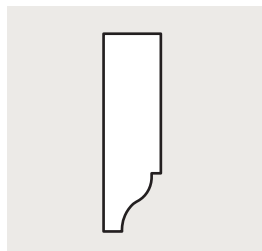

Dimensions:  
**100mm(h) x 30mm(w)**

## WA-108

3 Dimensional Visualisation

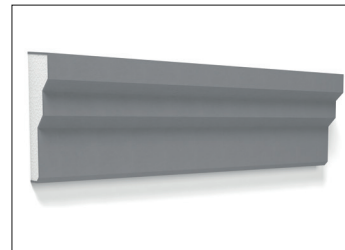

Side Profile

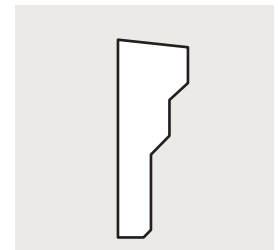

Dimensions:  
**110mm(h) x 40mm(w)**

## WA-109

3 Dimensional Visualisation

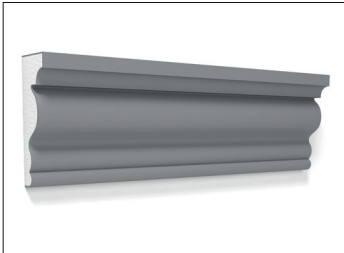

Side Profile

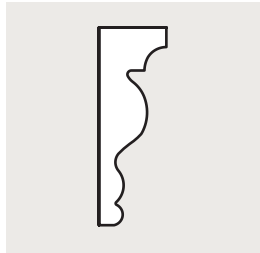

Dimensions:  
**115mm(h) x 40mm(w)**

## WA-110

3 Dimensional Visualisation

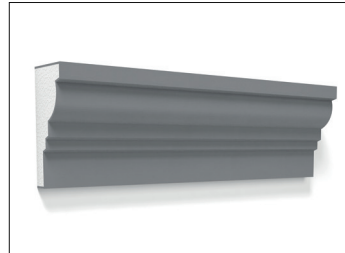

Side Profile

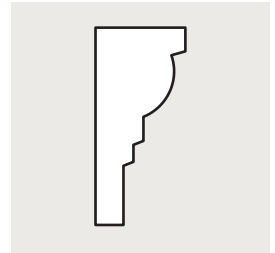

Dimensions:  
**115mm(h) x 50mm(w)**

## WA-111

3 Dimensional Visualisation

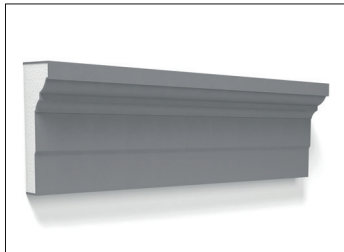

Side Profile

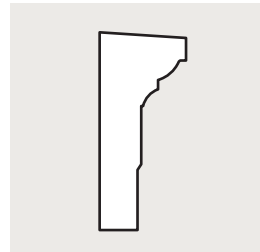

Dimensions:  
**120mm(h) x 55mm(w)**

## WA-112

3 Dimensional Visualisation

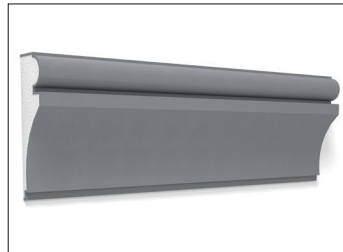

Side Profile

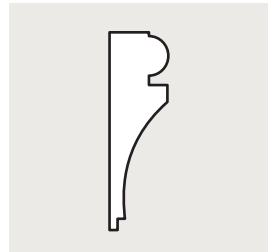

Dimensions:  
**125mm(h) x 40mm(w)**

## WA-113

3 Dimensional Visualisation

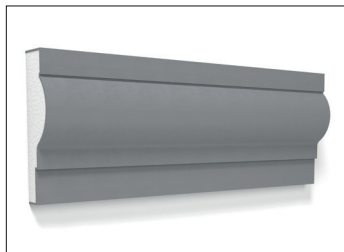

Side Profile

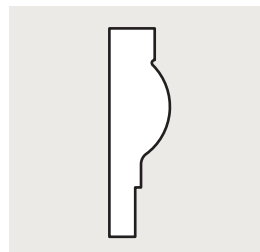

Dimensions:  
**135mm(h) x 40mm(w)**

## WA-114

3 Dimensional Visualisation

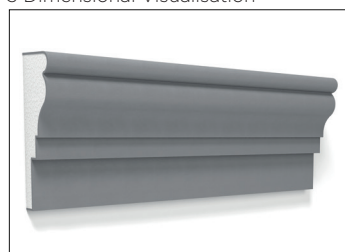

Side Profile

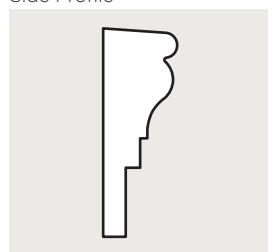

Dimensions:  
**140mm(h) x 50mm(w)**

## WA-115

3 Dimensional Visualisation

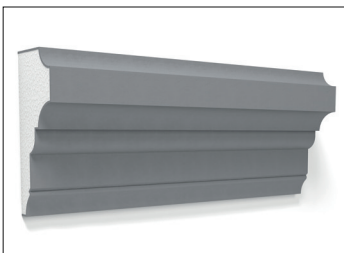

Side Profile

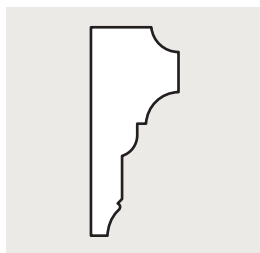

Dimensions:  
**150mm(h) x 65mm(w)**

## WA-116

3 Dimensional Visualisation

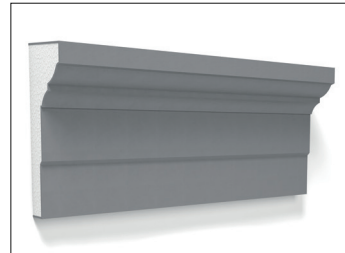

Side Profile

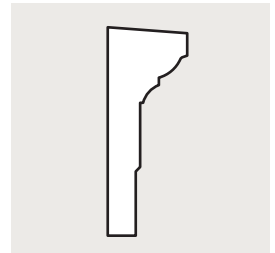

Dimensions:  
**165mm(h) x 65mm(w)**



## WS-201

3 Dimensional Visualisation

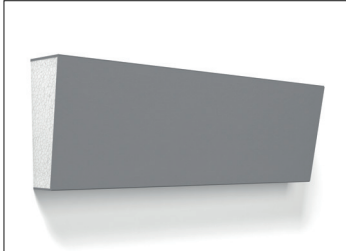

Side Profile



Dimensions:  
125mm(h) x 60mm(w)

## WS-201R

3 Dimensional Visualisation

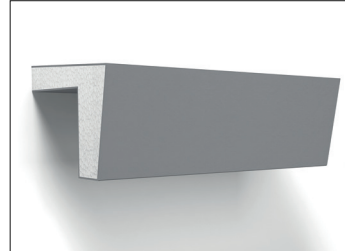

Side Profile



Dimensions:  
135mm(h) x 180mm(w)

## WS-202

3 Dimensional Visualisation

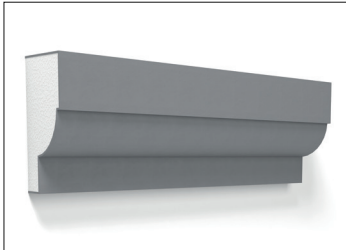

Side Profile

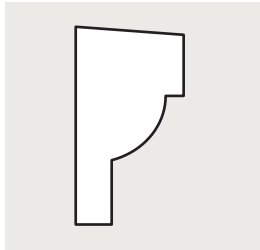

Dimensions:  
130mm(h) x 70mm(w)

## WS-202R

3 Dimensional Visualisation

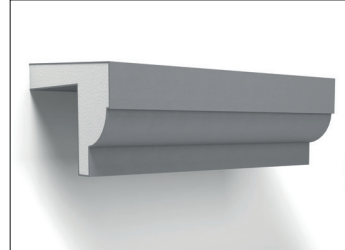

Side Profile

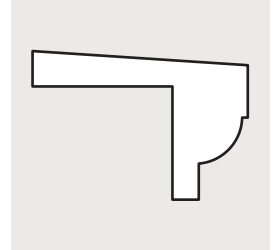

Dimensions:  
140mm(h) x 190mm(w)

## WS-203

3 Dimensional Visualisation

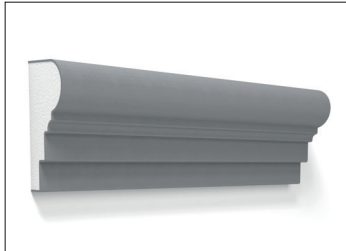

Side Profile

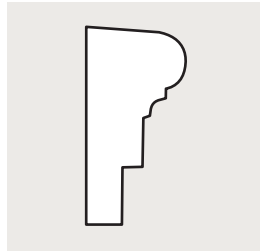

Dimensions:  
135mm(h) x 70mm(w)

## WS-203R

3 Dimensional Visualisation

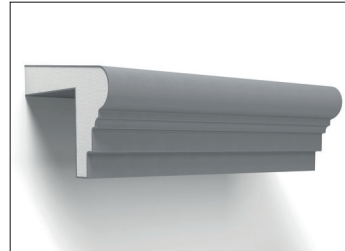

Side Profile

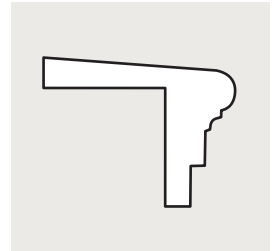

Dimensions:  
145mm(h) x 190mm(w)

## WS-204

3 Dimensional Visualisation

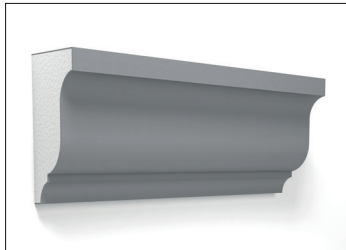

Side Profile

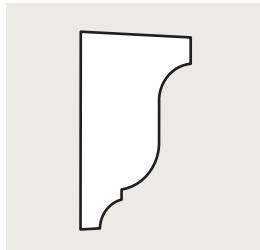

Dimensions:  
125mm(h) x 70mm(w)

## WS-205

3 Dimensional Visualisation

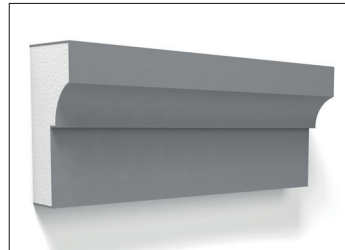

Side Profile

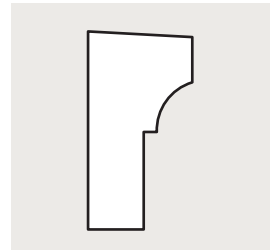

Dimensions:  
160mm(h) x 85mm(w)

PM-301

3 Dimensional Visualisation

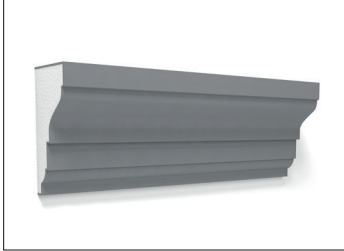

Side Profile

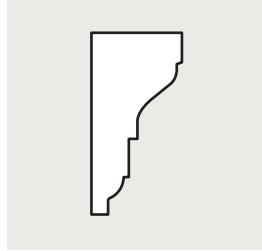

Dimensions:  
130mm(h) x 65mm(w)

PM-302

3 Dimensional Visualisation



Side Profile

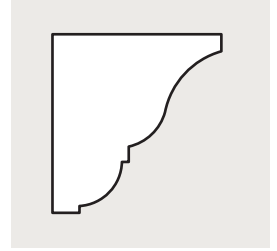

Dimensions:  
130mm(h) x 125mm(w)

PM-303

3 Dimensional Visualisation

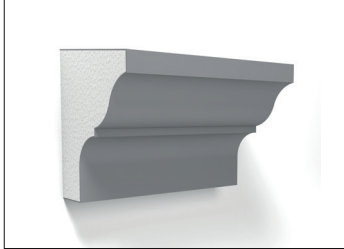

Side Profile

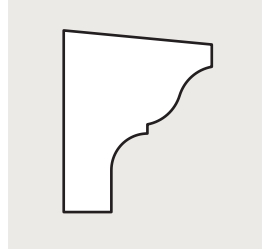

Dimensions:  
140mm(h) x 115mm(w)

PM-304

3 Dimensional Visualisation

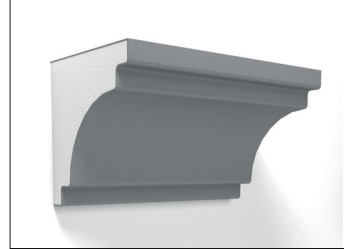

Side Profile

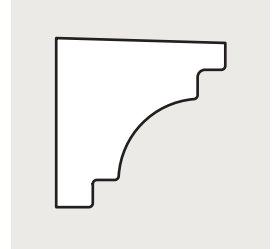

Dimensions:  
150mm(h) x 150mm(w)

PM-305

3 Dimensional Visualisation

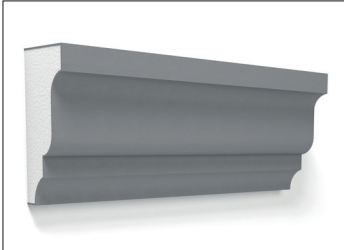

Side Profile

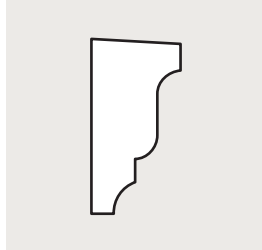

Dimensions:  
155mm(h) x 80mm(w)

PM-306

3 Dimensional Visualisation

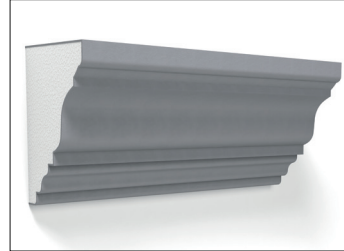

Side Profile

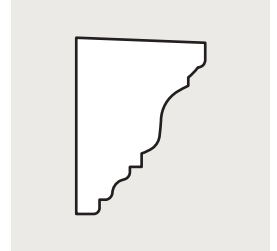

Dimensions:  
170mm(h) x 125mm(w)

PM-307

3 Dimensional Visualisation

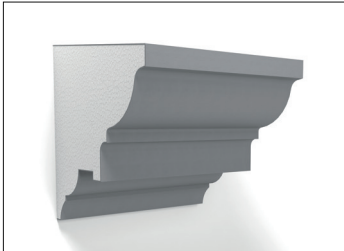

Side Profile

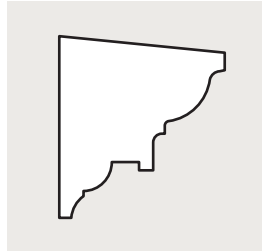

Dimensions:  
170mm(h) x 165mm(w)

PM-308

3 Dimensional Visualisation



Side Profile

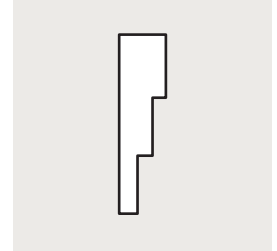

Dimensions:  
185mm(h) x 50mm(w)

PM-309

3 Dimensional Visualisation

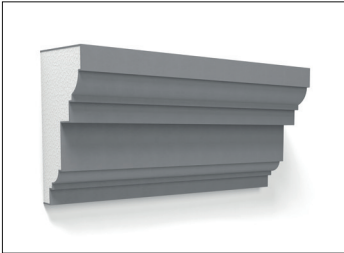

Side Profile

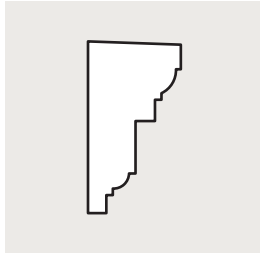

Dimensions:  
185mm(h) x 100mm(w)

PM-310

3 Dimensional Visualisation

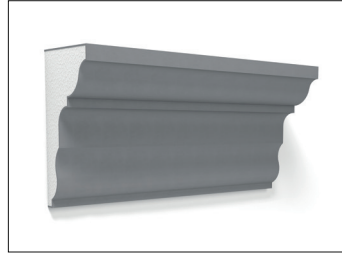

Side Profile

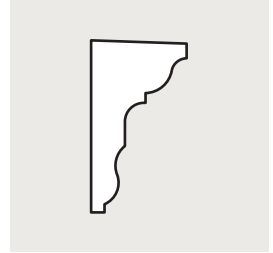

Dimensions:  
185mm(h) x 105mm(w)

PM-311

3 Dimensional Visualisation

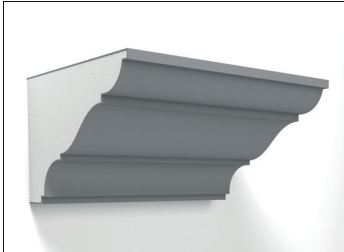

Side Profile

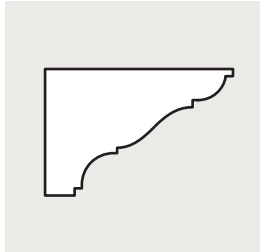

Dimensions:  
190mm(h) x 280mm(w)

PM-312

3 Dimensional Visualisation

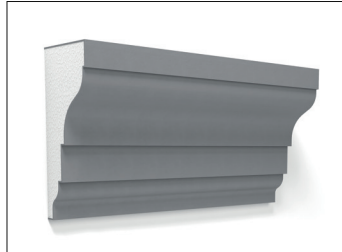

Side Profile

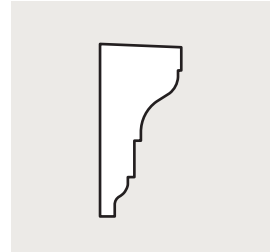

Dimensions:  
210mm(h) x 100mm(w)

PM-313

3 Dimensional Visualisation

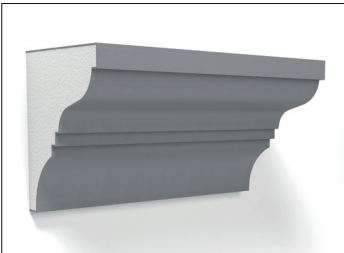

Side Profile

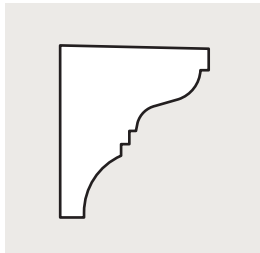

Dimensions:  
210mm(h) x 180mm(w)

PM-314

3 Dimensional Visualisation

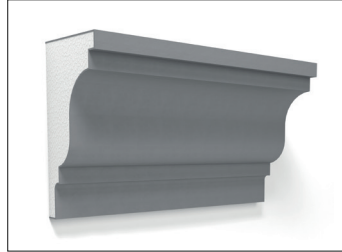

Side Profile

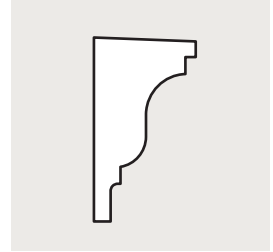

Dimensions:  
220mm(h) x 125mm(w)

PM-315

3 Dimensional Visualisation

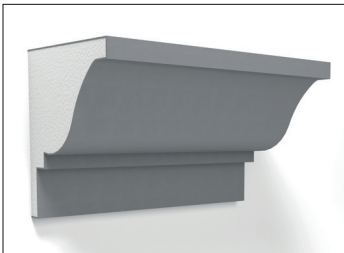

Side Profile

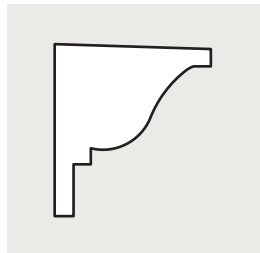

Dimensions:  
220mm(h) x 200mm(w)

PM-316

3 Dimensional Visualisation

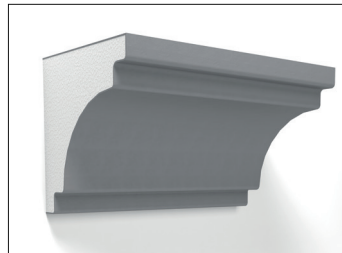

Side Profile

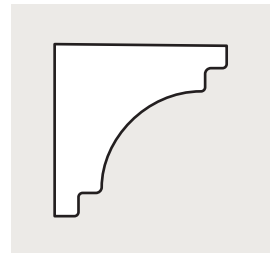

Dimensions:  
220mm(h) x 220mm(w)



PM-317

3 Dimensional Visualisation

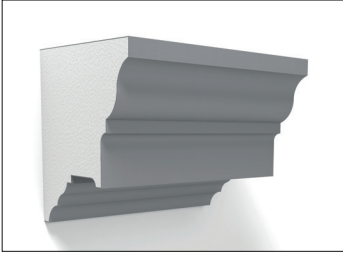

Side Profile

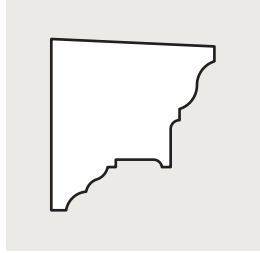

Dimensions:  
235mm(h) x 220mm(w)

PM-318

3 Dimensional Visualisation



Side Profile

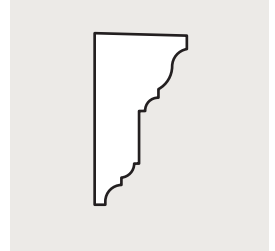

Dimensions:  
260mm(h) x 140mm(w)

PM-319

3 Dimensional Visualisation

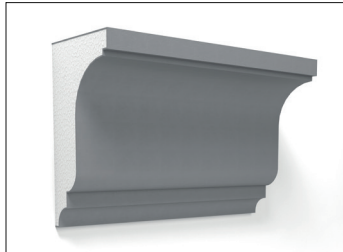

Side Profile

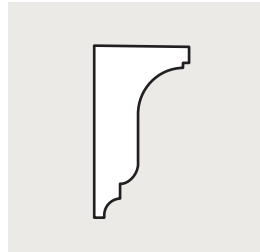

Dimensions:  
260mm(h) x 140mm(w)

PM-320

3 Dimensional Visualisation

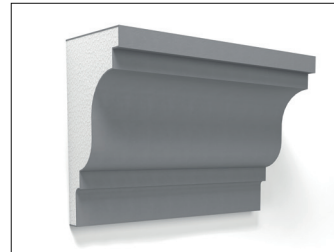

Side Profile

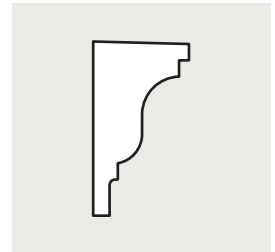

Dimensions:  
270mm(h) x 150mm(w)

PM-321

3 Dimensional Visualisation

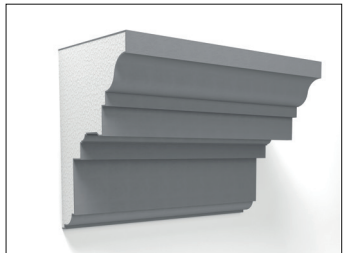

Side Profile

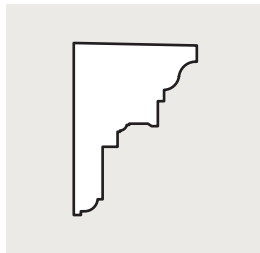

Dimensions:  
270mm(h) x 195mm(w)

PM-322

3 Dimensional Visualisation

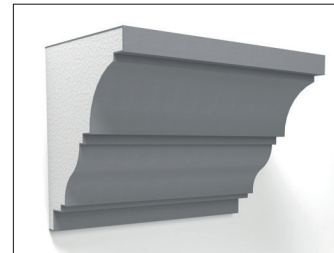

Side Profile

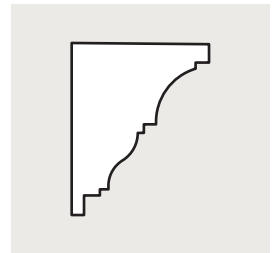

Dimensions:  
270mm(h) x 220mm(w)

PM-323

3 Dimensional Visualisation

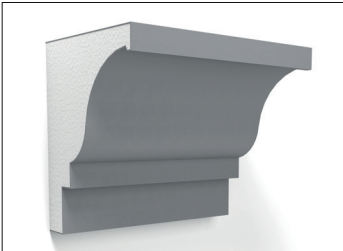

Side Profile

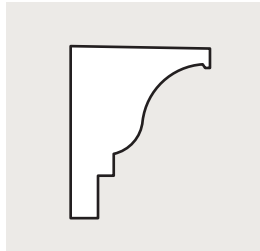

Dimensions:  
320mm(h) x 260mm(w)

PM-324

3 Dimensional Visualisation

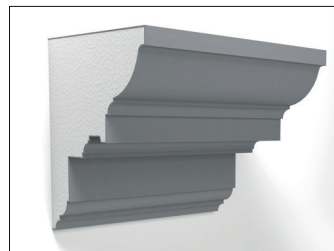

Side Profile

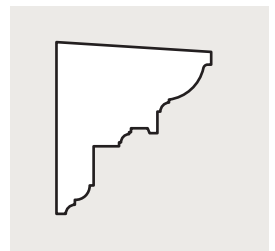

Dimensions:  
330mm(h) x 295mm(w)

PL-701

3 Dimensional Visualisation

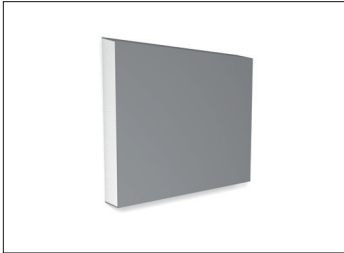

Side Profile

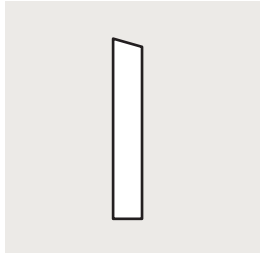

Dimensions:  
300mm(h) x 40mm(w)

PL-702

3 Dimensional Visualisation

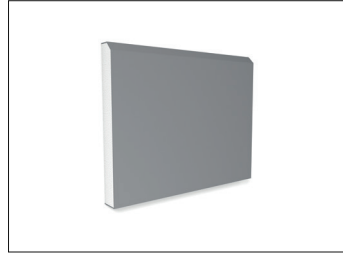

Side Profile

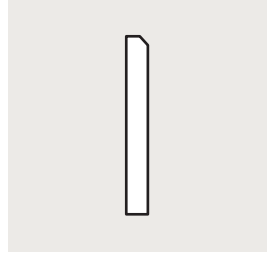

Dimensions:  
300mm(h) x 40mm(w)

PL-703

3 Dimensional Visualisation



Side Profile

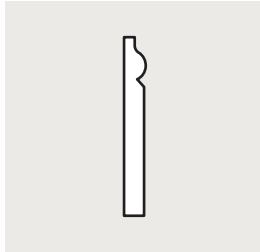

Dimensions:  
300mm(h) x 40mm(w)

PL-704

3 Dimensional Visualisation

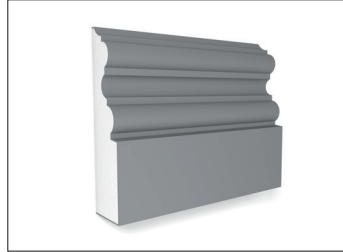

Side Profile

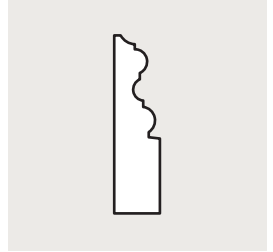

Dimensions:  
300mm(h) x 80mm(w)

PL-705

3 Dimensional Visualisation



Side Profile

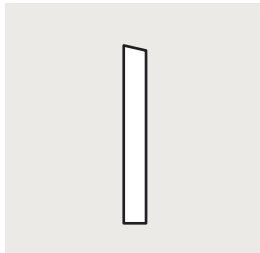

Dimensions:  
400mm(h) x 55mm(w)

PL-706

3 Dimensional Visualisation



Side Profile

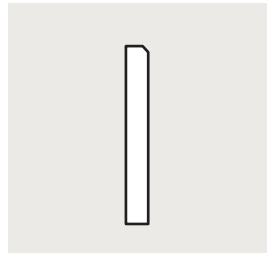

Dimensions:  
400mm(h) x 55mm(w)

## SM-401

3 Dimensional Visualisation

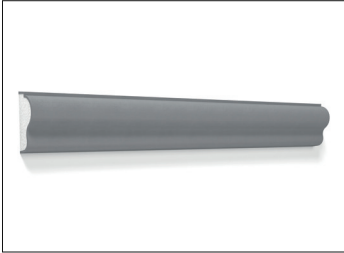

Side Profile

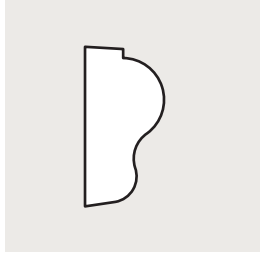

Dimensions:  
**50mm(h) x 25mm(w)**

## SM-402

3 Dimensional Visualisation

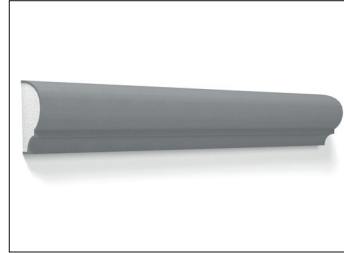

Side Profile

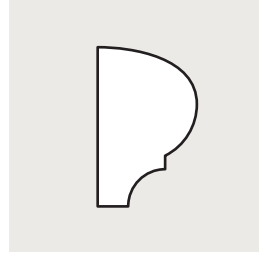

Dimensions:  
**60mm(h) x 35mm(w)**

## SM-403

3 Dimensional Visualisation



Side Profile

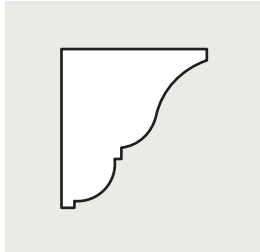

Dimensions:  
**60mm(h) x 55mm(w)**

## SM-404

3 Dimensional Visualisation

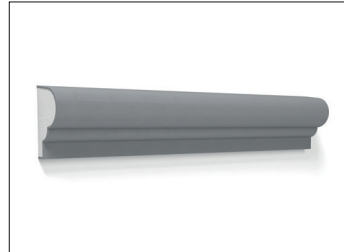

Side Profile

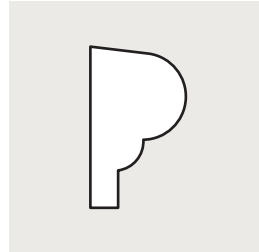

Dimensions:  
**65mm(h) x 40mm(w)**

## SM-405

3 Dimensional Visualisation

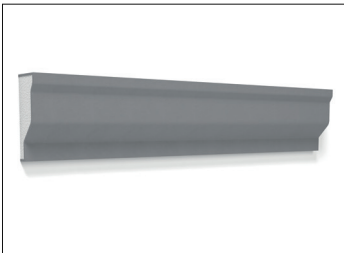

Side Profile

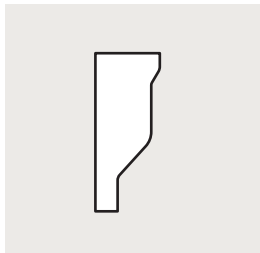

Dimensions:  
**70mm(h) x 30mm(w)**

## SM-406

3 Dimensional Visualisation

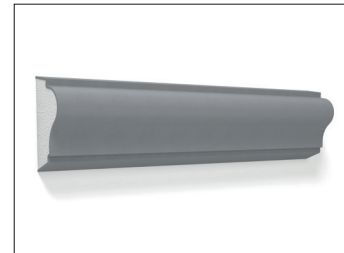

Side Profile

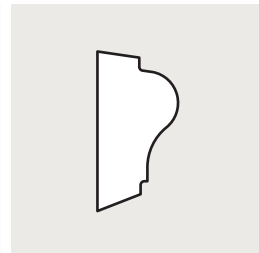

Dimensions:  
**90mm(h) x 45mm(w)**

## SM-407

3 Dimensional Visualisation

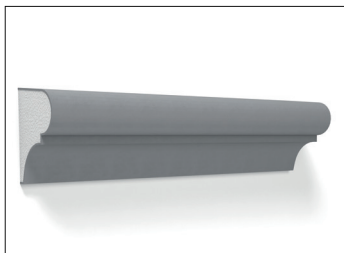

Side Profile

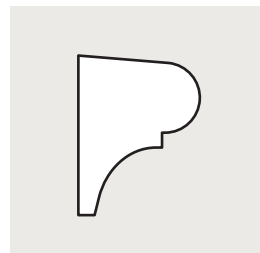

Dimensions:  
**90mm(h) x 70mm(w)**

## SM-408

3 Dimensional Visualisation

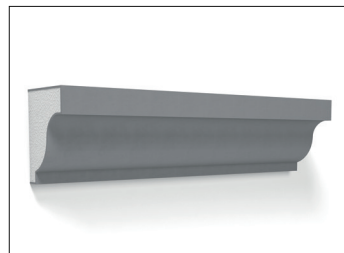

Side Profile

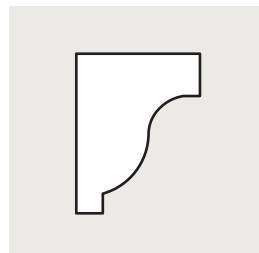

Dimensions:  
**90mm(h) x 70mm(w)**

## SM-409

3 Dimensional Visualisation

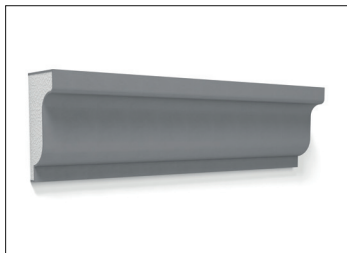

Side Profile

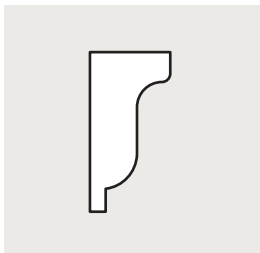

Dimensions:  
100mm(h) x 50mm(w)

## SM-410

3 Dimensional Visualisation

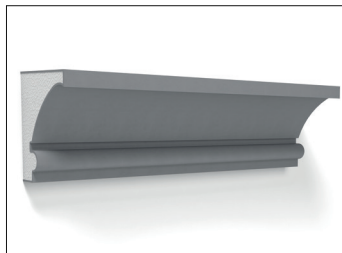

Side Profile

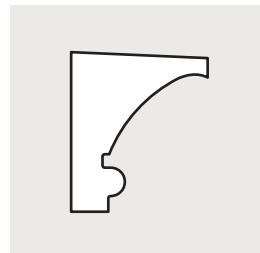

Dimensions:  
105mm(h) x 90mm(w)



FB-501

3 Dimensional Visualisation



Side Profile

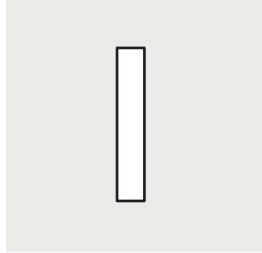

Dimensions:  
70mm(h) x 20mm(w)

FB-502

3 Dimensional Visualisation



Side Profile

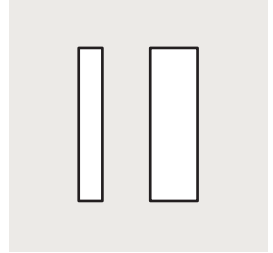

Dimensions:  
100mm(h) x 30mm(w); 100mm(h) x 50mm(w)

FB-503

3 Dimensional Visualisation



Side Profile

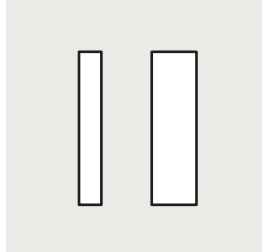

Dimensions:  
150mm(h) x 30mm(w); 150mm(h) x 40mm(w)

FB-504

3 Dimensional Visualisation



Side Profile

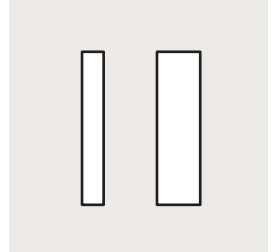

Dimensions:  
200mm(h) x 25mm(w); 200mm(h) x 40mm(w)

FB-505

3 Dimensional Visualisation



Side Profile

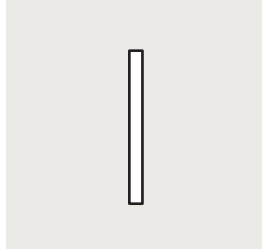

Dimensions:  
250mm(h) x 25mm(w)

FB-506

3 Dimensional Visualisation



Side Profile

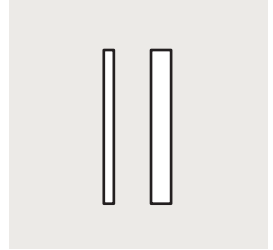

Dimensions:  
300mm(h) x 25mm(w); 300mm(h) x 40mm(w)

FB-507

3 Dimensional Visualisation



Side Profile

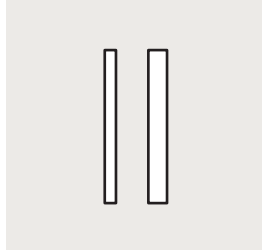

Dimensions:  
400mm(h) x 30mm(w); 400mm(h) x 50mm(w)

FB-508

3 Dimensional Visualisation



Side Profile

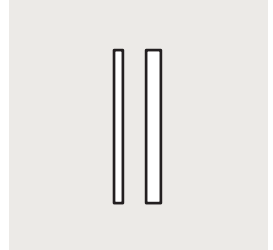

Dimensions:  
500mm(h) x 30mm(w); 500mm(h) x 50mm(w)

BM-601

3 Dimensional Visualisation

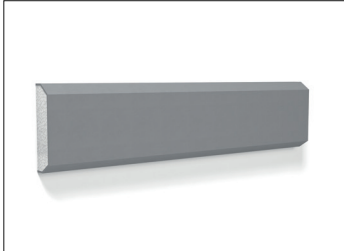

Side Profile

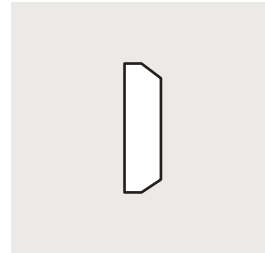

Dimensions:  
85mm(h) x 25mm(w)

BM-602

3 Dimensional Visualisation

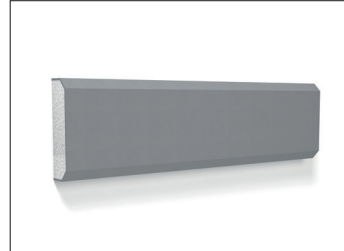

Side Profile

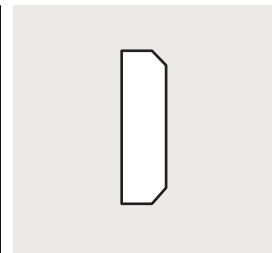

Dimensions:  
100mm(h) x 30mm(w)

BM-603

3 Dimensional Visualisation



Side Profile

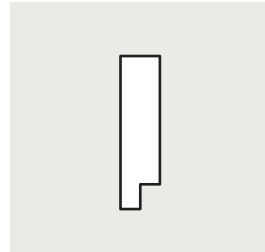

Dimensions:  
115mm(h) x 30mm(w)

BM-604

3 Dimensional Visualisation



Side Profile

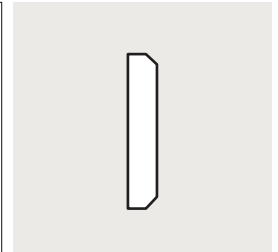

Dimensions:  
150mm(h) x 30mm(w)

BM-605

3 Dimensional Visualisation



Side Profile

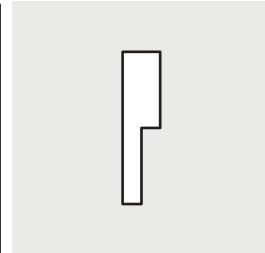

Dimensions:  
155mm(h) x 40mm(w)

BM-606

3 Dimensional Visualisation



Side Profile

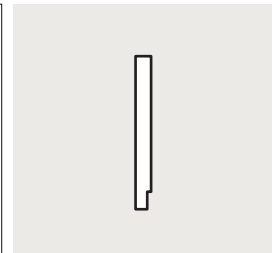

Dimensions:  
300mm(h) x 50mm(w)

BM-607

3 Dimensional Visualisation

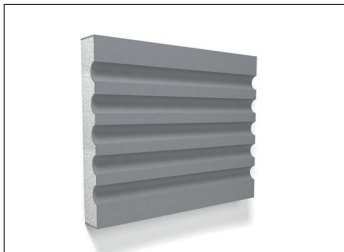

Side Profile

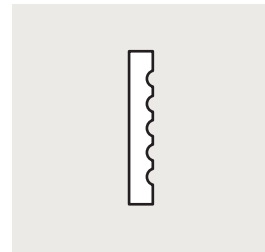

Dimensions:  
300mm(h) x 50mm(w)

BM-608

3 Dimensional Visualisation



Side Profile

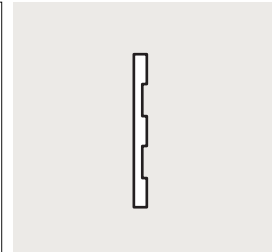

Dimensions:  
310mm(h) x 30mm(w)



PC-EDWARDIAN

3 Dimensional Visualisation

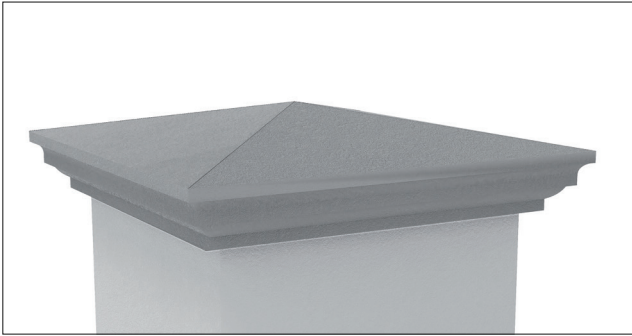

Side Profile

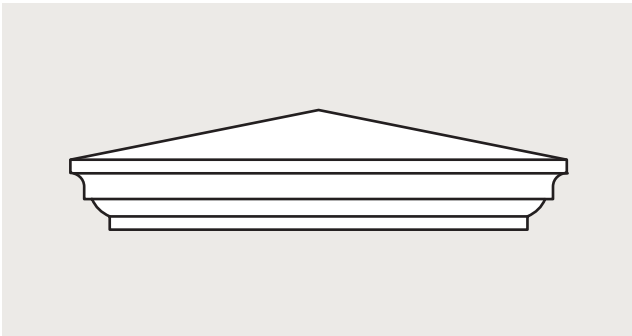

Dimensions:  
**180mm(h) x to suit(w)**

PC-VICTORIAN

3 Dimensional Visualisation

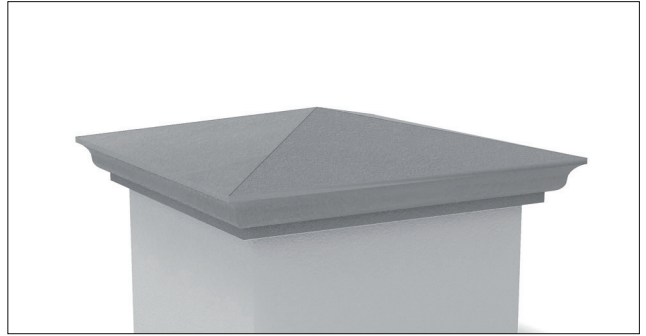

Side Profile

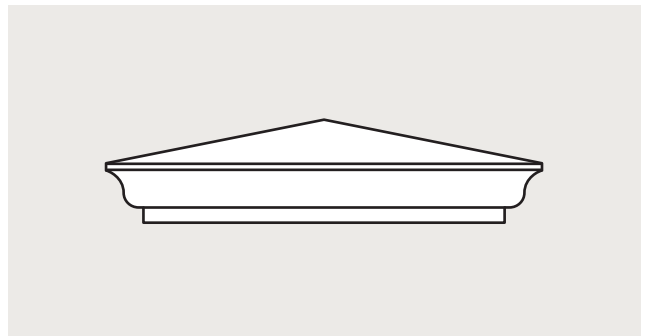

Dimensions:  
**155mm(h) x to suit(w)**

PC-GEORGIAN

3 Dimensional Visualisation

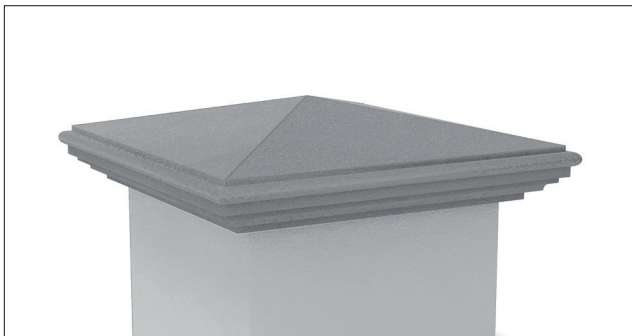

Side Profile

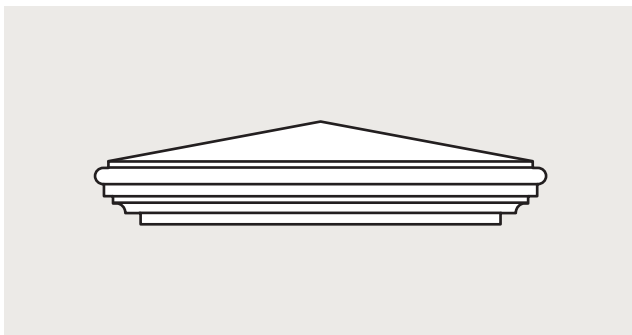

Dimensions:  
**155mm(h) x to suit(w)**

PC-PLAIN

3 Dimensional Visualisation

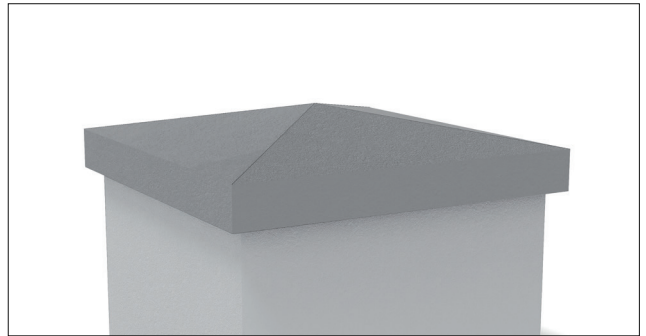

Side Profile

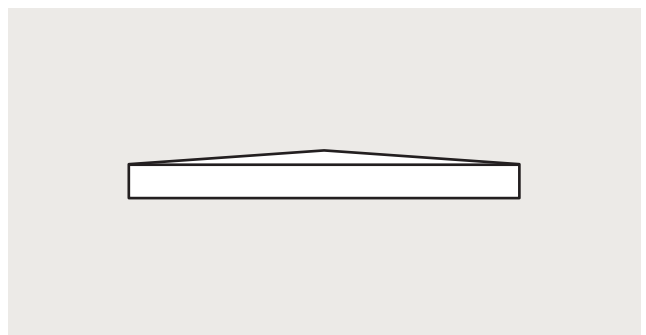

Dimensions:  
**70mm(h) x to suit(w)**

Standard sizes: 1.5 x 1.5 | 1.5 x 2 | 2 x 2 | 2.5 x 2.5 Brick Pier Size

PC-FRENCH SMALL

3 Dimensional Visualisation

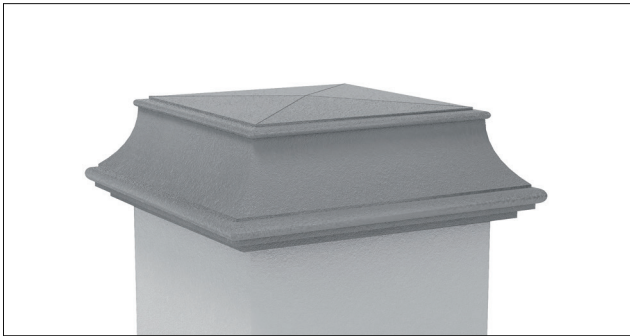

Side Profile

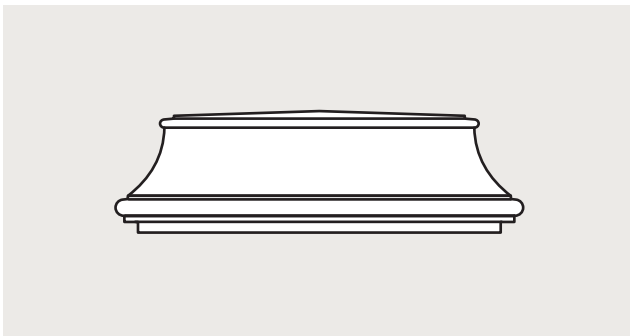

Dimensions:  
180mm(h) x to suit(w)

PC-FRENCH LARGE

3 Dimensional Visualisation

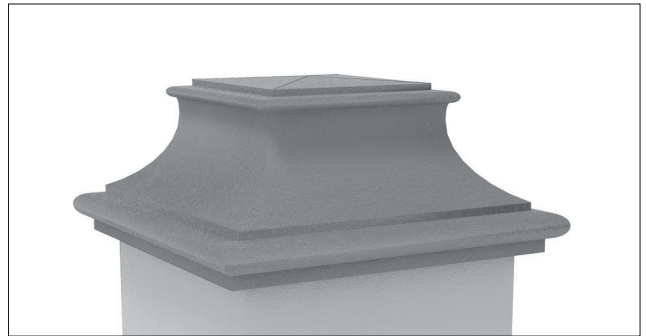

Side Profile

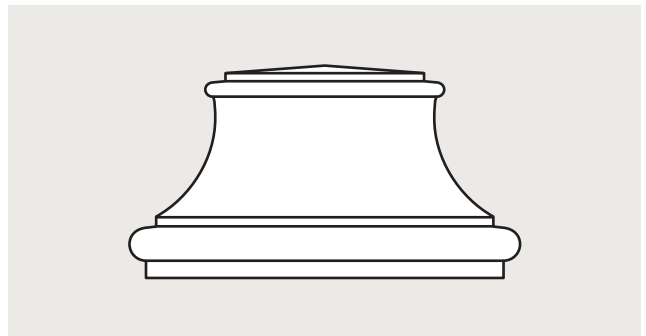

Dimensions:  
320mm(h) x to suit(w)

PC-FM180

3 Dimensional Visualisation

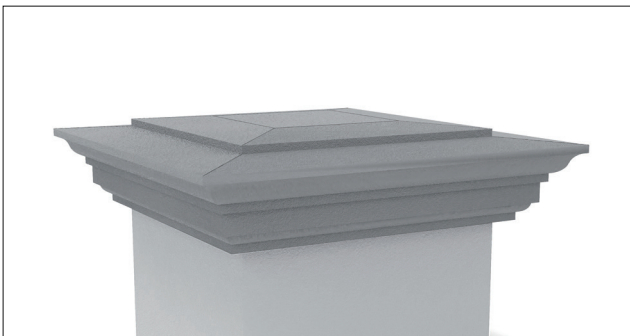

Side Profile

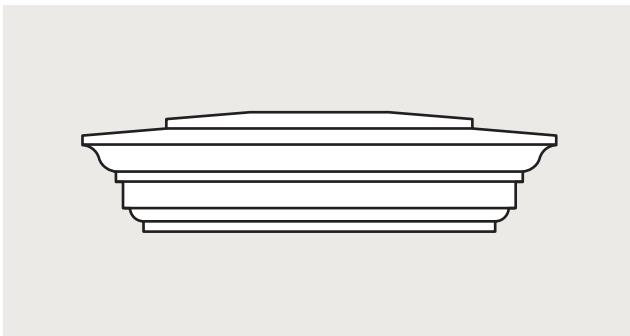

Dimensions:  
180mm(h) x to suit(w)

PC-FM250

3 Dimensional Visualisation



Side Profile

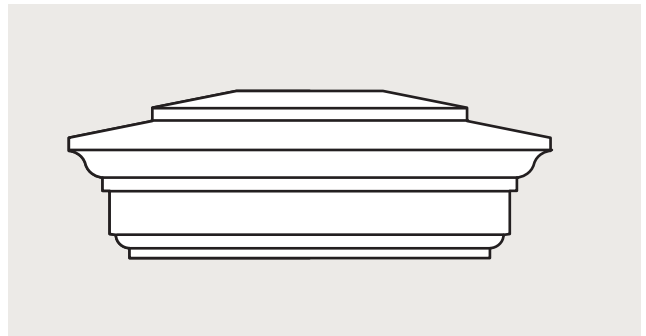

Dimensions:  
250mm(h) x to suit(w)

Standard sizes: 1.5 x 1.5 | 1.5 x 2 | 2 x 2 | 2.5 x 2.5 Brick Pier Size

DQ-BASE400

3 Dimensional Visualisation

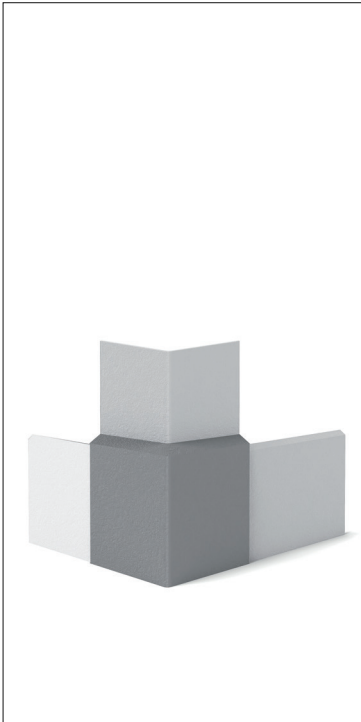

Side Profile

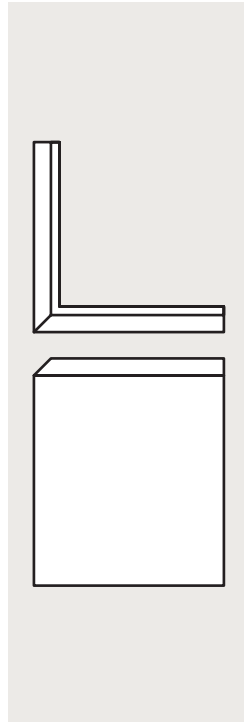

Dimensions:  
400mm(h) x 335mm(w)

DQ-QO135 L&R

3 Dimensional Visualisation

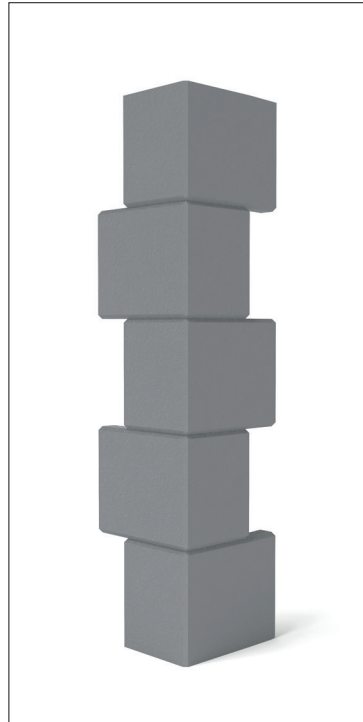

Side Profile

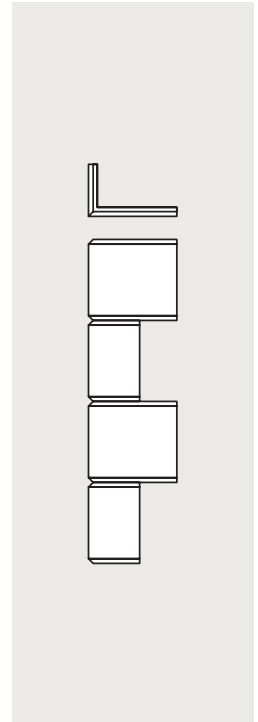

Dimensions:  
1370mm(h) x 380mm(w)

DQ-QSq270

3 Dimensional Visualisation

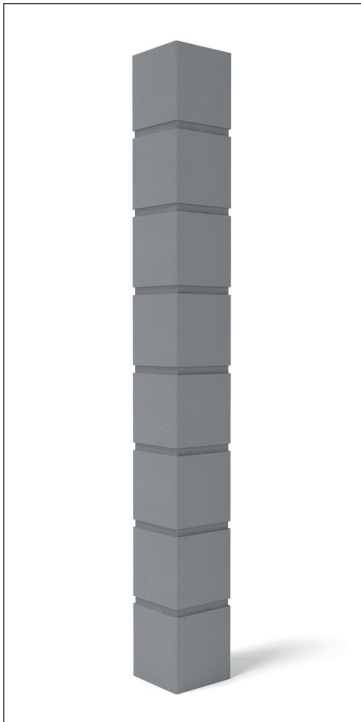

Side Profile

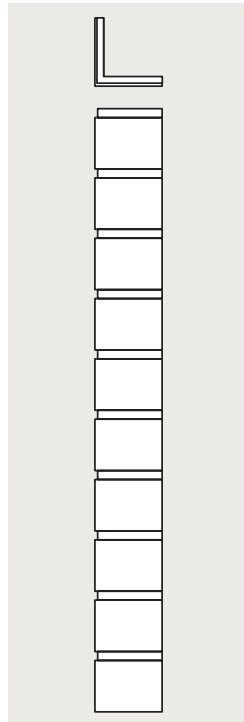

Dimensions:  
2700mm(h) x 305mm(w)

DQ-QV270 V SLOT

3 Dimensional Visualisation

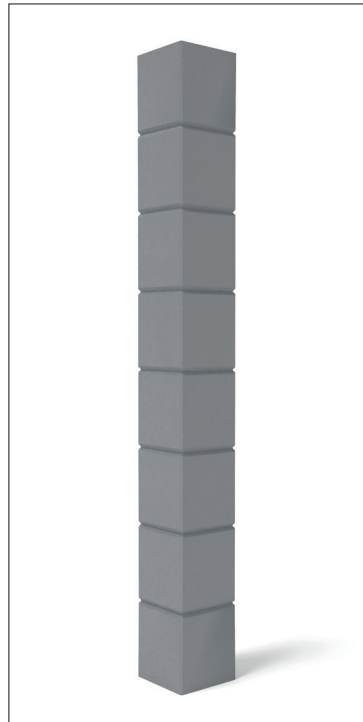

Side Profile

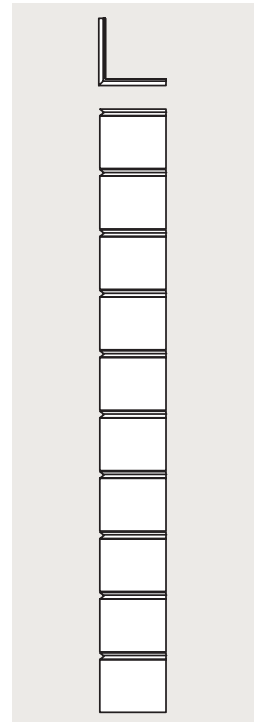

Dimensions:  
2700mm(h) x 305mm(w)

0477 477 750  
info@dekopro.com.au  
www.dekopro.com.au  
15 Drake Street,  
Sunshine North, VIC 3020

